

## Fluid Dispensing Equipment SELECTOR GUIDE

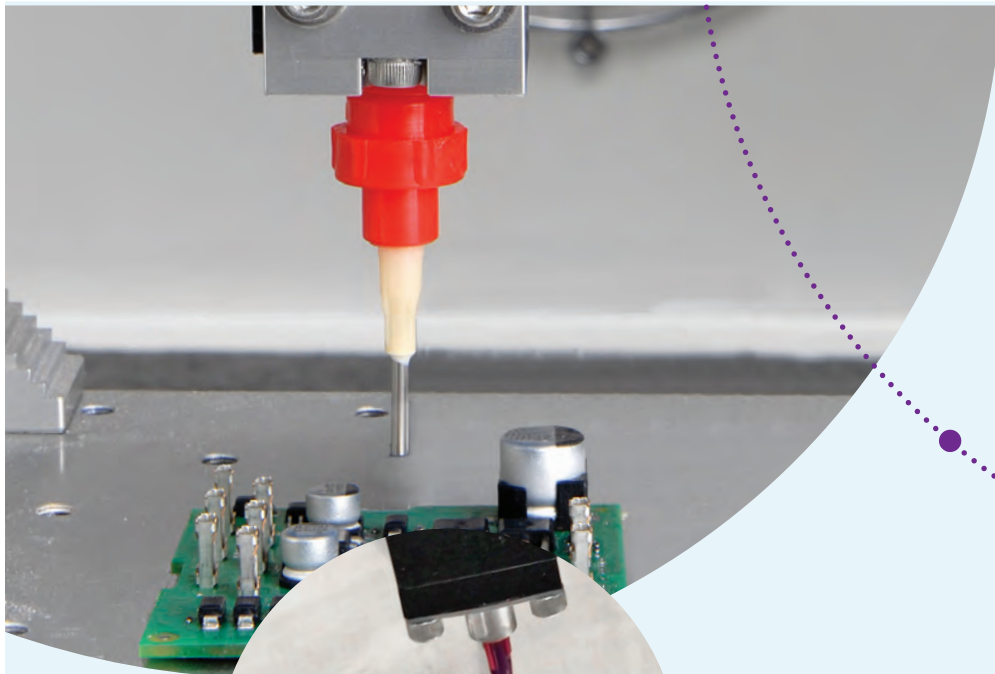

## Welcome to Dymax

Today's manufacturing is evolving at a faster rate than ever before. More complex designs, new materials, and an increased focus on the environment can present manufacturers with many new assembly challenges. Whatever demands or challenges you face, Dymax is here to work with you and provide the dispensing solutions you need for a more efficient process and higher quality end product.

Dymax manufactures high-grade, field-proven dispense systems that fit many manual and automated dispensing applications. These systems include various automatic and manual dispense systems, spray valves, and related components for seamless integration into your assembly process. Our dispensing systems are designed with features that eliminate common dispensing issues like material contamination, stringing at the dispense tip, and inaccurate flow control to help make your process as efficient as it can be. They're built for long, reliable service life with little maintenance to reduce downtime and repair costs.

For applications that require products outside our product offering, we partner with other leading dispensing companies to provide you with the best equipment for your process. This expands our dispensing resources while still providing all system components from a single supplier.

Much of the success of the application process will rely on the consistency of the fluid delivery system. Dymax application engineers and system integrators are available in each region to assist in the setup and integration of dispensing equipment and will be there to answer any of your questions long after the setup period.

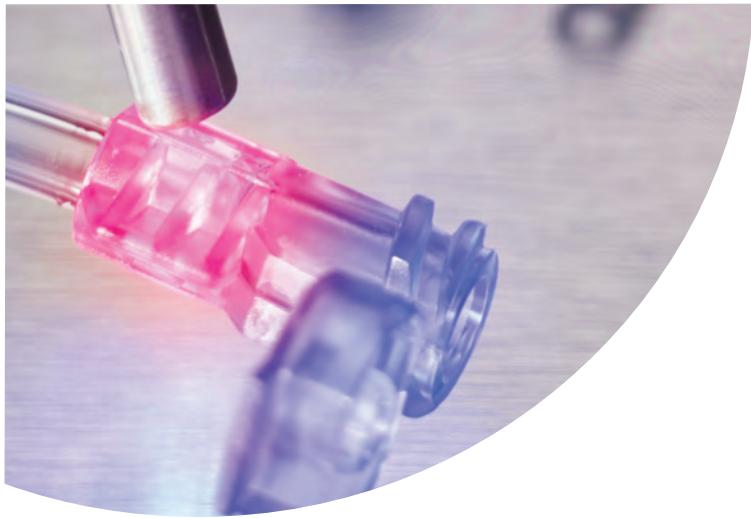

## Our Technology for Innovative Solutions.

At Dymax we combine our product offering with our expert knowledge of fluid delivery technology. Where others only supply products, we are committed to developing a true collaborative partnership, bringing our total process knowledge to our customer's specific application challenges. Because we understand the process as a whole, and not just individual aspects of it, we can offer our customers a solution where chemistry and equipment work seamlessly together with maximum efficiency. Our application engineering team works side-by-side with our customers, providing assistance with equipment selection and process design. We also have a system integrator who can help integrate new dispensing or curing components into an existing line.

## Dedicated to Reducing Environmental Impact











For the past 30 years, Dymax products have become the industry standard for fast, environmentally conscious assembly. Dymax products continue to replace technologies that contain hazardous ingredients, produce waste, or require higher amounts of energy to process.

Our dispensing systems are designed to lower product costs, life-cycle costs, and ecological impact.

## Contents

Comparison Chart .....	3
Syringe Dispenser .....	5
SD-200 .....	5
Micro-Dot™ .....	6
Stepper™ .....	6
Dispensing Valves .....	7
eco-PEN .....	7
200 .....	8
300 .....	8
400 .....	9
455 .....	9
826 .....	10
830 .....	10
475 .....	11
485 .....	11
775 .....	12
HLC Dispensing Systems .....	13
Spray Systems .....	14
SG-150 .....	14
SG-200 .....	14
455 Spray .....	15
eco-SPRAY .....	15
Accessories .....	16
Dispense Project Questionnaire .....	22

# Dispensing Equipment Selector Chart

Model Number	Micro-Dot™	Stepper™	SD-200	eco-PEN	200	300	400	455	HLC Dispense Pen	
										
Dispense Data	Dispense Modes	Shot	Shot	Shot (timed), Continuous bead	Volumetric	Shot (timed), Continuous (bead)			Shot (timed), Continuous (bead)	Shot (timed), Continuous (bead)
	Shot Sizes	0.0002 - 0.25 mL (15/18 GA Taper Tip)	0.01 - 0.10 mL 0.05 - 0.25 mL	-	.004 ml – continuous 0.50 – 6.00 ml/min	-	-	0.002 mL to Continuous Flow	0.003 mL (0.066" tubing) to Continuous Flow	-
	Viscosity Range	Medium to High	Medium to High	Low to High	Low to High	Up to 5,000 cP			Medium to High	Low to High
Mechanical Specs	Materials*	UV Adhesives, Grease, Inks	UV Adhesives, Greases, Inks, Medical Fluids	UV Adhesives, Greases, Inks	UV Adhesives, Greases, Inks, Medical Fluids	UV Adhesives, Cyanoacrylates, Inks	UV Adhesives, Cyanoacrylates, Inks	UV Adhesives, Inks	UV Adhesives, Cyanoacrylates, Inks	Hybrid Light-Curables
	Operation	Manual Syringe Dispenser	Manual Pipette	Powered Syringe Dispenser	Volumetric Pump	Diaphragm	Diaphragm	Needle	Disposable Fluid Path	Diaphragm
	Control	Manual Positive Displacement		Time Pressure	Programmable Positive Displacement	Manual Pressurized	Time Pressure	Time Pressure	Time Pressure	Manual Pressurized
	Disposable Fluid Path	Yes		Yes	No	No	No	No	Yes	Yes
	Controller	None		Integrated	EC200 2.0	None	DVC-345	DVC-345	DVC-345	None
Utilities	Operational Adjustments	Displacement		Time, Pressure, Suck-Back	Flow, Suck-Back	Flow	Flow	Flow	Over Pinch, Flow	Flow
	Electrical Required	None		100-240 VAC	110V	None	110V (for controller only) 100-240 VAC		110V (for controller only) 100-240 VAC	None
Valve Materials	Compressed Air Required	No		Yes	Yes	Yes	Yes	Yes	Yes	Yes
	Supply Reservoirs	3, 5, 10 cc Syringe (most brands)	1, 3, 5 cc Syringe	3, 5, 10, 30, 55 cc Syringe	Any	Cartridge or Pressure Pot	Cartridge or Tank	Cartridge or Tank	Cartridge or Pressure Pot	Pressure Pot
	Valve Body (non-wetted)	N/A		N/A	Anodized AL	Acetal	Acetal	Acetal	Anodized AL	N/A
	Wetted Path	Syringe & Tip		Syringe & Tip	HD-POM / SS	Acetal	Acetal	SS/AL	Selected Tubing	Tube & Tip
CE Approval	Wetted Valve Seals	N/A		N/A	High-molecular PE, VisChem	PTFE	PTFE	Silicone	N/A	N/A
	Tubing	N/A		N/A	N/A	Polyethylene	Polyethylene	Polyethylene	Polyethylene	Polyethylene
CE Approval	N/A	N/A	✓	✓	✓	✓	✓	✓	N/A	

\* If there is any question about material compatibility, please contact Dymax Application Engineering.  
Valves containing disposable fluid path technology offer several choices of tubing to ensure proper compatibility with the fluid being dispensed.

## Application Overview

Features	Micro-Dot™	Stepper™	SD-200	eco-PEN	200	300	400	455	HLC Dispense Pen
Viscosity Range**	Med-High	Med-High	Low-Med-High	Low-Med	Low-Med	Low-Med	Low-Med	Med-High	Low-High
Microdots	●	●	●	●			●		●
Dots	●	●	●	●	●	●	●	●	●
Beads			●	●	●	●	●	●	●
Potting			●	●	●	●	●	●	●
Spray - Conformal Coatings									
Spray - Maskants									

\*\* Low Viscosity= < 1000 cP      Medium Viscosity= 1000 cP - 10,000 cP      High Viscosity= >10,000 cP+

# Dispensing Equipment Selector Chart

Model Number	826	830	475	485	775-Series	SG-150	SG-200	455 Spray	eco-SPRAY	
										
Dispense Data	Dispense Modes	Shot (timed), Continuous (bead)		Shot (timed), Continuous (bead)			Spray		Micro-Spray	Volumetric Micro-Spray
	Shot Sizes	0.005 mL	0.02 mL	0.004 mL to Continuous Flow	0.002 mL to Continuous Flow	0.01 mL to Continuous Flow	Flat: 0.75 - 2+" [1.91 - 5.08+ cm] Round: 0.25 - 2" [0.64 - 5.08 cm]	Round: 2 - 8" [5.08 - 20.32 cm]	Round: .05 ml - continuous	Round: .05 ml - continuous 0.50 - 6.00 ml/min
	Viscosity Range	Low to High (including stringy)	High (including stringy)	Low to Medium	Low to High	Medium to High (including stringy)	RS: <10,000 cP RH: >10,000 cP	High	Low to Medium (<5,000)	Low to High
	Materials*	UV Adhesives, Cyanoacrylates, Inks	UV Adhesives, Cyanoacrylates	UV Adhesives, Cyanoacrylates, Inks	UV Adhesives, Inks	UV Adhesives, Greases, Inks	Conformal Coatings, UV Maskants		UV Adhesives, Cyanoacrylates, Inks	UV Adhesives, Cyanoacrylates, Inks
Mechanical Specs	Operation	Disposable Fluid Path	Disposable Fluid Path	Diaphragm	Needle	Spool	Needle		Disposable Fluid Path	Spray, Dispense
	Control	Time Pressure	Time Pressure	Time Pressure			Fluid Pressure, Atomization Pressure		Time Pressure	Programmable Positive Displacement
	Disposable Fluid Path	Yes	Yes	No			No	No	Yes	No
	Controller	DVC-345	DVC-345	DVC-345			DVC-345		DVC-345	SC1200
	Operational Adjustments	Over Pinch, Flow, Suck-Back	Over Pinch, Flow, Suck-Back	Flow	Flow	Flow, Suck-Back	Flow		Over Pinch, Flow	Flow, Suck-Back
Utilities	Electrical Required	110V (for controller only) 100-240 VAC		110V (for controller only) 100-240 VAC			110 V (for controller only) 100-240 VAC		110V (for controller only) 100-240 VAC	110V
	Compressed Air Required	Yes	Yes	Yes			Yes		Yes	Yes
Supply Reservoirs	Cartridge or Pressure Pot	Cartridge or Pressure Pot	Syringe, Cartridge, or Tank			Cartridge or Tank		Cartridge or Pressure Pot	Any	
Valve Materials	Valve Body (non-wetted)	Anodized AL	Anodized AL	SS, Anodized AL			SS		Anodized AL	Anodized AL
	Wetted Path	Selected Tubing	Selected Tubing	Acetal	Acetal/SS	SS/AL	SS		Selected Tubing	HD-POM/SS
	Wetted Valve Seals	N/A	N/A	UHMW PE	Silicone	PTFE or KFM	PTFE, KKFM		N/A	High-Molecular PE, VisChem
	Tubing	Polyethylene	Polyethylene	Polyethylene	Polyethylene	Polyethylene	Polyethylene	Polyethylene	Polyethylene	N/A
CE Approval	✓	✓	✓	✓	✓	✓	✓	✓	✓	

\* If there is any question about material compatibility, please contact Dymax Application Engineering.  
Valves containing disposable fluid path technology offer several choices of tubing to ensure proper compatibility with the fluid being dispensed.

## Application Overview

Features	826	830	475	485	775-Series	SG-150	SG-200	455 Spray	eco-SPRAY
Viscosity Range**	Low-Med-High	High	Low-Med	Low-Med-High	Med-High	RS: Low-Med RH: Med-High	High	Low-Med	Low-Med-High
Microdots	•			•					
Dots	•	•	•	•	•				•
Beads	•	•	•	•	•				•
Potting	•	•	•		•				•
Spray - Conformal Coatings						•	•	•	•
Spray - Maskants						•	•	•	•

\*\* Low Viscosity= < 1000 cP      Medium Viscosity= 1000 cP - 10,000 cP      High Viscosity= >10,000 cP +

## Powered & Manual Syringe Dispensers

Dymax syringe dispensers deliver accurate and consistent fluid deposits from pre-packed disposable syringes. By using a disposable syringe as the material reservoir, these dispensing systems eliminate the risk of material contamination during dispense and allow for quick and easy product changeover with no cleanup. These dispensers are simple to set up and operate and can be used to dispense a wide variety of low- to high-viscosity fluids. Dymax powered syringe dispensers can also be easily integrated into automated processes.

### SD-200 DIGITAL SYRINGE DISPENSER



The SD-200 digital syringe dispenser accurately dispenses low-to-high viscosity materials from a syringe. Operators can quickly and easily set the system up for the required deposit size with the digital timer control and adjustable pressure gauge. The SD-200 is ideal for use as an operator work station and can also be integrated into an automated process by connecting an external signal to the system input.

- Digital timer with a range of 0.01-9999 seconds for precise control over dispense
- Timed or manual mode with adjustable time and pressure settings
- Adjustable vacuum suck-back for clean, drip-free shut-off
- Consistency from first to last dispense



Specifications	
Part Number	60600
Power Required	100-240 VAC, 50/60 Hz
Air Pressure Required	7.56" x 7.17" x 3.00" [192 mm x 182 mm x 76 mm]
Dimensions	8.625" x 8.5" x 2.625" [22 cm x 21 cm x 6.7 cm]
Weight	2.14 lbs [0.97 kg]

# Powered & Manual Syringe Dispensers

## MICRO-DOT™ MANUAL SYRINGE DISPENSER

The Micro-Dot™ system combines the efficiency of disposable syringes with a precise, repeatable, and reusable, manually actuated delivery device. This hand-held dispenser can be set to deliver volumes as small as 20 microliters. Once volume is set it can be repeated indefinitely with extreme accuracy.

Specifications	T20000	T20010
Activation	Thumb	Lever
Dimensions	4.5" x 0.87" x 2.13" [11.4 cm x 2.2 cm x 5.4 cm]	
Weight	2.8 oz [81.3 g]	2.8 oz [81.3 g]
Shot Size, Minimum	0.0003 mL*	0.0003 mL*
Shot Size, Maximum	0.170 mL**	0.170 mL**

\* 400 cP material with 25 GA taper tip

\*\* 400 cP material with 14 GA taper tip



- Positive-displacement dispensing with adjustable stroke
- Portable design; no power or air required
- Disposable fluid reservoir for no material contamination
- Compatible with standard machine-ready syringes (3,5, & 10 mL)

## STEPPER™ PIPETTES

The Dymax Stepper™ is a simple to operate, repetitive dispensing pipette. With this pipette, users have the ability to set a specific dispense volume and repeat it over and over again with extreme accuracy. It utilizes a disposable, silicone-free, medical-grade syringe as its fluid reservoir and is designed so the reservoir never comes in contact with the operator's hand, preventing adverse heat transfer which could influence the accuracy of the pipette. The pipette also eliminates fluid contamination by preventing fluids from coming in contact with the dispenser. The contaminant-free dispensing this pipette offers is ideal for lab applications or other work with sterile fluids.

Specifications	T15469	T15471
Syringe Size	1 mL	3 mL
Needle Gauge	21	21
Shot Range	0.01 - 0.10 mL	0.05 - 0.25 mL
Dispense Increments	0.01 mL	0.05 mL
Accuracy	± 5.0%	±2.0%
Repeatability	± 2.5%	±2.0%

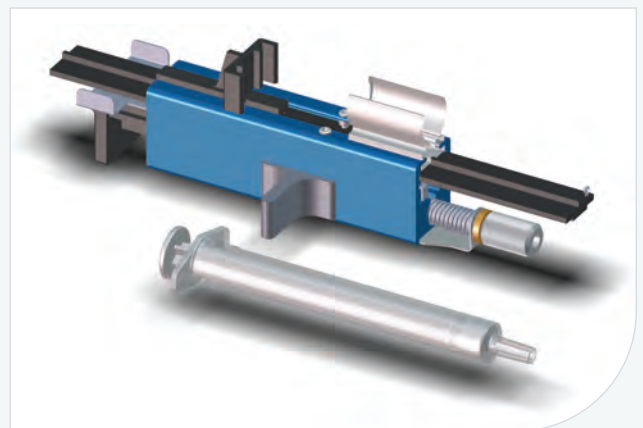

- Small, portable, ergonomic design
- Positive displacement accuracy
- Consistency from first to last dispense
- All wetted parts are disposable eliminating material compatibility issues or contamination

# Handheld & Mountable Dispensing Systems

Dymax offers handheld and mountable dispensing systems for manual or automated dispensing processes. Our dispensing systems are available with disposable fluid path, diaphragm, needle, and spool valves.

## Disposable Fluid Path Valves

(Contaminant-Free Dispensing)

Dymax disposable fluid path valves are uniquely engineered to prevent material contamination. The disposable fluid path carries materials from the material reservoir to the dispense tip, sealing fluids in the fluid path. This prevents the fluid from coming in contact with the valve's inner components and ensures a contaminant-free dispensing process. The fluid path is easy to replace and requires minimal clean-up, allowing for rapid material changeover.



## Diaphragm Valves

(No Fluid Contamination with Less Maintenance)

Diaphragm valves are ideal for dispensing light-curable materials, solvent-based products, and reactive materials like cyanoacrylates and anaerobics because the internal design of the valve prevents fluid from coming in contact with the valve's actuating components. This drastically minimizes valve maintenance and production down-time.



## Needle Valves (Extreme Precision Dispensing)

Needle valves are designed to deliver precise dots or very fine beads of low- to medium-viscosity fluids. Dymax needle valves feature a stroke adjustment which allows for fine-tuning of the dispense volume and ensures precise and consistent deposits. Handheld and mountable models are available.



## Spool Valves (Accuracy with Suck-Back Control)

Spool valves are ideal for automated dispensing systems and are designed to accurately dispense a variety of medium- to high-viscosity fluids. The valves' accuracy comes from two main features: suck-back control and adjustable flow control. The suck-back feature assures consistent, string-less dispensing of tackier materials and prevents droplets from remaining on the dispense nozzle when using lower viscosity materials.

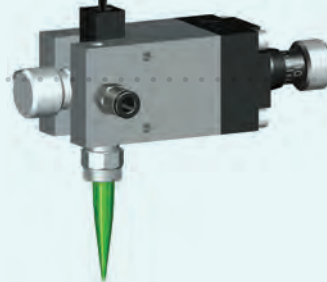



# Handheld & Mountable Dispensing Systems

## VISCOTEC ECO-PEN450 HANDHELD DOSING SYSTEM

The ViscoTec eco-PEN450 dispensing system is a rotating and perfectly pressure-tight displacement system ideally suited for dispensing precise volumes of low- to medium-viscosity materials. This dispensing pen has a self-sealing, rotor/stator design. Conveyance is by medium displacement in the stator through tightly controlled rotor rotation, assuring accurate dispensing without any changes to the dispense material.

- Controllable dosing flow
- Suck-back feature for clean shut-off
- Range of dosing pressures 16-20 bar



Specifications	
Valve Type	Handheld Positive Displacement
Activation	eco-CONTROL EC200 2.0
Dimensions	1.30" D x 8.27" H [3.3 cm x 21 cm]
Part Numbers	T18557 eco-PEN450 Dispensing Valve T40500 eco-CONTROL EC200 2.0 T18560 Valve Mounting Fixture

## MODEL 200 HANDHELD DISPENSING SYSTEM

The Model 200 dispensing system features a manually-controlled valve which uses a unique floating diaphragm to achieve accurate dispensing. It's wand-style body is more ergonomic and the valve's design allows for compatibility with a variety of low-to-medium viscosity fluids, including light-curable adhesives, cyanoacrylates, and anaerobic adhesives.

- Lightweight, ergonomic design for easy handling
- Portable design; no power or air required
- Ideal for dot, bead, or potting applications with fluids up to 5,000 cPs



Specifications	
Valve Type	Handheld Diaphragm, Normally Closed
Activation	DVC-345 or 2-Position, 4-Way Solenoid Valve
Dimensions	7.63" x 1.75" [19.37 cm x 4.45 cm]

Available Systems					
Valve Only	Cartridge Reservoir			Bottle Drop-In (<1 Gallon)	Pail Drop-In (<15 Liters)
	6 oz	12 oz	20 oz		
T17020	T17699	T17700	T17701	T17702	T17703

All systems include a Model 300 valve, DVC-345 controller, selected reservoir, fluid line kits, valve stand, air precision regulator, air line kits, air filter/regulator, and tip kit.

# Handheld & Mountable Dispensing Systems

## MODEL 300 HANDHELD DISPENSING SYSTEM

The Model 300 dispensing system's diaphragm valve is compact and lightweight, making it easy and comfortable to handle. Accurate, repeatable dispensing can be achieved by utilizing the valve's material flow adjustment to control the shot volume. The internal diaphragm design of the valve prevents fluid from contacting the actuating components within the valve, reducing damage and wear, while extending the life of the valve. The valve's design also makes it ideal for dispensing light-curable materials, solvent-based products, and reactive materials like cyanoacrylates and anaerobics.

- Ideal for low-to-medium viscosity fluids
- Diaphragm design minimizes necessary maintenance
- Material flow adjustment for precise control over dispense volumes



Specifications	
Valve Type	Handheld Diaphragm, Normally Closed
Activation	DVC-345 or 2-Position, 4-Way Solenoid Valve
Dimensions	7.63" x 1.75" [19.37 cm x 4.45 cm]

Available Systems					
Valve Only	Cartridge Reservoir			Bottle Drop-In (<1 Gallon)	Pail Drop-In (<15 Liters)
	6 oz	12 oz	20 oz		
T17020	T17699	T17700	T17701	T17702	T17703

All systems include a Model 300 valve, DVC-345 controller, selected reservoir, fluid line kits, valve stand, air precision regulator, air line kits, air filter/regulator, and tip kit.

## MODEL 400 HANDHELD DISPENSING SYSTEM

The Model 400 dispensing system features a compact and lightweight needle valve. It's designed to deliver precise dots or very fine beads. Air pressure retracts the valve's needle assembly from the seat allowing fluid to flow from the valve fluid inlet to the dispensing tip. When the air pressure is eliminated, the spring returns the needle back to its position, closing the fluid path and ending the dispense cycle. Accurate, repeatable dispensing can be achieved by utilizing the valve's material flow adjustment to control the shot volume.

- Lightweight, ergonomic design for easy handling
- Extreme precision even at small sizes
- Ideal for low-to-medium viscosity fluids



Specifications	
Valve Type	Pneumatic Needle Valve, Normally Closed
Activation	DVC-345 or 2-Position, 4-Way Solenoid Valve
Dimensions	7.09" x 1.25" [3.22 cm x 0.57 cm]

Available Systems							
Valve Only	Complete System Without Reservoir	Cartridge Reservoir			Bottle Drop-In (<1 Gallon)	Mini Ram Pump (Up to 3.8 L)	Pail Drop-In (<15 Liters)
		6 oz	12 oz	20 oz			
T17384	T17838	T17704	T17705	T17706	T17707	T17840	T17708

All systems include a Model 400 valve, DVC-345 controller, selected reservoir, fluid line kits, valve stand, air precision regulator, air line kits, air filter/regulator, and tip kit.

# Handheld & Mountable Dispensing Systems

## MODEL 455 DISPOSABLE FLUID PATH DISPENSING SYSTEMS

Model 455 systems feature a pinch valve with a disposable fluid path. The valve's micrometer control feature allows users to precisely adjust the material flow, insuring that materials are dispensed consistently and accurately. The Model 455's disposable fluid path carries materials from the material reservoir to the dispense tip. Fluids are sealed within the fluid path, preventing contact with the valve's inner components and ensuring a contaminant-free dispensing process. The fluid path is easy to replace and requires minimum clean-up, allowing for rapid material changeover.

- Ideal for low- to medium-viscosity materials
- Varying fluid path materials and sizes for optimum material compatibility
- Disposable fluid path for contaminant-free dispensing and easy product changeover
- Stroke adjustment for precise control over dispensing volumes and shot-to-shot consistency



Specifications	
Valve Type	Pneumatic Pinch, Normally Closed
Activation	DVC-345 or 3-Way Solenoid Valve
Dimensions	3.75" x 1.125" x 1.125" [9.53 cm x 2.86 cm x 2.86 cm]

Available Systems						
Tubing Size/Material	Valve Only	Cartridge Reservoir			Bottle Drop-In (<1 Gallon)	Pail Drop-In (<15 Liters)
		6 oz	12 oz	20 oz		
0.066" PTFE	T16029	T17415	T17417	T17419	T17421	T17738
0.095" PTFE	T17552	T17739	T17740	T17741	T17742	T17743
0.125" PE	T17555	T17744	T17745	T17746	T17747	T17748

All systems include a Model 455 valve, selected reservoir, fluid line kits, stand, air precision regulator, air line kits, air filter/regulator, and tip kit.

## MODEL 826 DISPOSABLE FLUID PATH DISPENSING SYSTEMS

Model 826 systems are specifically designed to easily dispense thicker, stringy materials. The 826 valve is highly precise, obtaining its precision from lockable controls that facilitate the adjustment of flow rate, tube closure, and suck back. The valve also features a disposable fluid path which carries materials from the material reservoir to the dispense tip. Fluids are sealed within the fluid path, preventing contact with the valve's inner components and ensuring a contaminant-free dispensing process. The fluid path is easy to replace and requires minimum clean-up, allowing for rapid material changeover.

- Adjustable suck back for handling thick and stringy materials
- Varying fluid path materials and sizes for optimum material compatibility
- Disposable fluid path for contaminant-free dispensing and easy product changeover
- Stroke adjustment for precise control over dispensing volumes and shot-to-shot consistency



Specifications	
Valve Type	Pneumatic Pinch, Normally Closed
Activation	DVC-345 or 3-Way Solenoid Valve
Dimensions	3.75" x 1.125" x 1.125" [9.53 cm x 2.86 cm x 2.86 cm]

Available Systems					
Valve Only	Cartridge Reservoir			Bottle Drop-In (<1 Gallon)	Pail Drop-In (<15 Liters)
	6 oz	12 oz	20 oz		
T17586	T17805	T17806	T17807	T17808	T17809

All systems include a Model 826 valve with 0.25" OD PE tubing, selected reservoir, fluid line kits, stand, air precision regulator, air line kits, air filter/regulator, and tip kit.

# Handheld & Mountable Dispensing Systems

## MODEL 830 DISPOSABLE FLUID PATH VALVE

The Model 830 pinch valve is designed to provide larger flow rates while still maintaining precise control over material flow rate. The Model 830's disposable fluid path carries materials from the material reservoir to the dispense tip. Fluids are sealed within the fluid path, preventing contact with the valve's inner components and ensuring a contaminant-free dispensing process. The fluid path is easy to replace and requires minimum clean-up, allowing for rapid material changeover.

- Dispenses low-to-high viscosity materials and features suck back for handling stringy and tacky materials with no mess
- Valve accepts fluid paths of varying materials and sizes for optimum material compatibility
- Disposable fluid path for contaminant-free dispensing and easy product changeover



Specifications	
Valve Type	Pneumatic Pinch, Normally Closed
Activation	DVC-345 or 3-Way Solenoid Valve
Dimensions	3.13" x 3.13" x 1.75" [7.94 cm x 7.94 cm x 4.45 cm]

Available Systems							
Valve Only	Complete System Without Reservoir	Cartridge Reservoir			Bottle Drop-In (<1 Gallon)	Pail Drop-In (Up to 3.8 L)	Pail Drop-In (<15 Liters)
		6 oz	12 oz	20 oz			
T18196	T18538	T18543	T18544	T18545	T18546	T17852	T18547

All systems include a Model 830 valve, DVC-345 controller, selected reservoir, fluid line kits, valve stand, air precision regulator, air line kits, air filter/regulator, and tip kit.

## MODEL 475 DIAPHRAGM DISPENSING SYSTEM

This system utilizes a pneumatic, normally closed diaphragm valve to accurately dispense low- to high-viscosity fluids. The valve's internal diaphragm design prevents contact between the fluid and actuating components within the valve, decreasing wear on the actuating components and minimizing valve maintenance and production down-time. This feature also makes the system ideal for dispensing reactive materials like cyanoacrylates and solvent-based products. Accurate, repeatable performance can be achieved by utilizing the valve's stroke adjustment to precisely dial-in a desired shot volume.

- Lightweight for easy handling and mounting
- Extreme precision even at small sizes
- Ideal for low- to high-viscosity fluids including reactive solvent-based materials
- Material flow adjustment for precise control over dispense volumes



Specifications	
Valve Type	Pneumatic Diaphragm, Normally Closed
Activation	DVC-345 or 3-Way Solenoid Valve
Dimensions	1.125" x 5.42" x 1.125" [2.86 cm x 13.77 cm x 2.86 cm]

Available Systems						
Valve Only	Complete System Without Reservoir	Cartridge Reservoir			Bottle Drop-In (<1 Gallon)	Pail Drop-In (<15 Liters)
		6 oz	12 oz	20 oz		
T15988	T17361	T17362	T17365	T17359	T17369	T17371

All systems include a Model 475 valve, DVC-345 controller, selected reservoir, fluid line kits, valve mounting assembly, lab stand, air precision regulator, air line kits, air filter/regulator, and tip kit.

# Handheld & Mountable Dispensing Systems

## MODEL 485 NEEDLE DISPENSING SYSTEM

The Model 485 dispensing system is designed to deliver precise dots or very fine beads of low- to high-viscosity fluids. The valve's stroke adjustment allows for fine-tuning of the dispense volume, ensuring precise and consistent deposits. This system is ideally suited for a wide range of applications including glob-top dispensing and dispensing UV light-curable adhesives.

- Lightweight for easy handling and mounting
- Ideal for low-to-high viscosity fluids
- Shot-to-shot consistency (when used with DVC-345 controller)
- Material flow adjustment for precise control over dispense volumes



Specifications	
Valve Type	Pneumatic Needle, Normally Closed
Activation	DVC-345 or 3-Way Solenoid Valve
Dimensions	1.13" x 5.14" x 1.13" [2.87 cm x 13.06 cm x 2.87 cm]

Available Systems							
Valve Only	Complete System Without Reservoir	Cartridge Reservoir			Bottle Drop-In (<1 Gallon)	Mini Ram Pump (Up to 3.8 L)	Pail Drop-In (<15 Liters)
		6 oz	12 oz	20 oz			
T17617	T17832	T17731	T17732	T17733	T17734	T17837	T17735

All systems include a Model 485 valve, DVC-345 controller, selected reservoir, fluid line kits, valve mounting assembly, air precision regulator, air line kits, air filter/regulator, and tip kit.

## MODEL 775 SPOOL DISPENSING SYSTEM

Model 775 systems are designed to accurately dispense a variety of medium- to high-viscosity fluids and can dispense volumes as little as 0.01 mL and as large as 50 mL. The valve's accuracy comes from two main features, adjustable suck back and flow control. The Model 775 spool valve is ideally suited for automated applications.

- Adjustable suck back for crisp, clean shut-off of materials
- Available with PTFE or FKM seals
- Adjustable and lockable flow control for accurate dispensing shots
- Lightweight for easy handling and mounting



Specifications	
Valve Type	Modified Spool, Normally Closed
Activation	DVC-345 or 3-Way Solenoid Valve
Dimensions	1.25" x 5.42" x 1.25" [3.18 cm x 13.77 cm x 3.18 cm]

Available Systems								
	Valve Only	Complete System Without Reservoir	Cartridge Reservoir			Bottle Drop-In (<1 Gallon)	Mini-Ram Pump (Up to 3.8 L)	Pail Drop-In (<15 Liters)
			6 oz	12 oz	20 oz			
PTFE Seals, 1/4" NPT	T15853	T17855	T17755	T17756	T17757	T17758	N/A	T17759
PTFE Seals, 1/4-28 NPT	T15855	N/A	T17760	T17761	T17762	T17763	T17857	T17764
FKM Seals, 1/4" NPT*	T15859	-	T17750	T17751	T17752	T17753	-	T17754

\* FKM (fluoroelastomer) seals are not compatible with UV-curable adhesives

All systems include a Model 775 valve, selected reservoir, fluid line kits, stand, air precision regulator, air line kits, air filter/regulator, and tip kit.

# Handheld & Mountable Dispensing Systems

## HLC Dispensing Systems

Dymax offers two systems for easy, accurate dispensing of hybrid light-curable materials - a system featuring a handheld dispensing pen and a system with a mountable dispensing valve. Both systems feature a mini drop-in pressure tank that eliminate the need for down packing, and utilize disposable fluid paths, ensuring a contaminant-free dispensing process.

### HLC DISPENSING PEN SYSTEM

The HLC Dispensing Pen system utilizes a handheld pen valve to accurately dispense Dymax hybrid light-curable materials, providing precise control for continuous or shot applications. It is compact and lightweight for comfortable handheld operation, and requires no controller or electricity for dispense activation.



### HLC MODEL 455 SYSTEM

This system kit is specially curated for use with Dymax hybrid light-curable materials. It utilizes the Model 455 valve and DVC-345 controller to accurately dispense HLC materials in both automated dispensing lines or bench-top setups.



HLC Dispense System Kits		
	Dispensing Pen System	Model 455 System
Valve Type	Handheld	Mountable
Dispensing Valve	HLC Dispense Pen	Model 455
Material Reservoir	Mini Drop-In Pressure Tank	
Activation	Manual Pinch	DVC-345
Tubing Size/Material	0.095" PE & 0.095" PTFE	0.095" PTFE
Features	<ul style="list-style-type: none"> <li>• Compact and lightweight for comfortable handheld operation</li> <li>• Ideal for continuous or micro-shot applications</li> <li>• Built-in flow adjustment for precise control over dispensing volumes and shot-to-shot consistency</li> <li>• No controller or electricity needed</li> <li>• Disposable fluid path for contaminant-free dispensing and easy product changeover</li> </ul>	<ul style="list-style-type: none"> <li>• Easily integrated into automated lines or can be used as a bench-top dispensing station</li> <li>• Stroke adjustment for precise control over dispensing volumes and shot-to-shot consistency</li> <li>• DVC-345 controller provides precise and consistent valve actuation without complex programming</li> <li>• Cycle time may be set in a range from .01 to 9.99 seconds in .01 second increments</li> <li>• Disposable fluid path for contaminant-free dispensing and easy product changeover</li> </ul>
System Part Number	T40648 <sup>1</sup>	T40665 <sup>2</sup>
Accessories & Spare Parts	T40647 - HLC Pen Dispense Spare Kit T40627 - Pen Dispense Valve Only	T18376 - Fluid Line, 0.095" P3232 - Tip Kit, 18GA, 1.25"

<sup>1</sup>Includes a HLC dispense pen valve, mini drop-in pressure tank, 60g bottle nest, air precision regulator with stand assembly, syringe stand, fluid line kit, air line kit, and tip kit.

<sup>2</sup>Includes a Model 455 valve, mini drop-in pressure tank, 60g bottle nest, air precision regulator with stand assembly, syringe stand, complete DVC-345 controller, wye adapter, fluid line kit, air line kit, and tip kit.

## Spray Systems

Dymax offers standard and high-flow spray valves for use in automated dispensing systems as well as spray guns for manually spraying materials. Dymax spray equipment is ideal for use with a number of different materials including masking resins, conformal coatings, solvents, grease, and lubricants.

### SG-150 SPRAY GUN SYSTEM

SG-150 spray systems, available in standard and high-flow models, utilize a needle valve to control fluid flow and have a dual-acting air cylinder that provides immediate start/stop functionality. A stroke adjustment on the valve can be used to fine tune the flow rate and a precision air regulator/gauge assembly simultaneously activates the atomizing air while the valve is opened and fluid is flowing.

- Standard and high flow models available
- Ideal for spraying conformal coatings, maskants, solvents, or lubricants

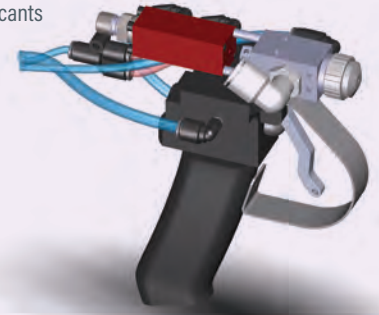

Specifications	
Valve Type	SS Needle, Normally Closed
Dimensions	2.20" D x 6.45" H [11.4 cm x 2.2 cm]

Available Systems								
Available Models	Spray Gun Only	Cartridge Reservoir			Bottle Drop-In (<1 Gallon)	Pail Drop-In (<15 Liters)	Mini Ram Pump (Up to 3.8 L)	Ram Pump (<15 Liters)
		6 oz	12 oz	20 oz				
Standard Flow, <10,000 cP	T18435	T18440	T18445	T18450	T18455	T18465	-	-
High Flow, >10,000 cP	T18449	T18442	T18446	T18451	T18456	T18466	T17848	T18471 (Tapered) T18470 (Straight)

All systems include a SG-150 spray gun with controlling air regulators and round cap, selected reservoir, fluid line kits, stand, air precision regulator, air line kits, and air filter/regulator.

### SG-200 SPRAY GUN SYSTEM

Dymax's super-flow spray systems are designed for masking and coating applications where a significantly higher flow rate is required. The systems are ideal for dispensing fluids with viscosities up to 80,000 cP and provide a flow rate that is 5-10 times higher than the SG-100 spray guns. Flow rates of 2.5-20 oz per minute are achievable, maximizing productivity for heavy-deposit, high-volume, and large-part masking and coating applications.

- Handheld and machine mount flexibility
- Ideal for spraying maskants, solvents, grease, and other lubricants



Specifications	
Valve Type	SS Needle, Normally Closed
Flow Rates	2.5-20 oz per minute

Available Systems						
Spray Gun Only	Cartridge Reservoir		Bottle Drop-In (<1 Gallon)	Pail Drop-In (<15 Liters)	Mini-Ram Pump (Up to 3.8 L)	Ram Pump (<15 Liters)
	12 oz	20 oz				
T21232	T21235	T21245	T20270	T21280	T17850	T21285-001 (Tapered) T21285-002 (Straight)

All systems include a SG-200 spray gun with controlling air regulators, DVC-345 valve controller, selected reservoir, fluid line kits, stand, air precision regulator, air line kits, and air filter/regulator.

# Spray Systems

## MODEL 455 MICRO-SPRAY VALVE

The Model 455 valve can be outfitted with a stainless steel spray nozzle and spray regulator assembly. The spray nozzle is an external air-mix type which utilizes a standard luer-lock design allowing different gauge tips to be exchanged to adjust flow rate needs. The combination of tip variation and integrated pneumatic controls allows control over the amount of air relative to the amount of fluid.

Specifications	
Valve Type	Pneumatic Pinch Valve, Normally Closed
Activation	DVC-345 or 3-Way Solenoid Valve
Dimensions	3.75" x 4" x 5" [9.53 cm x 10.16 cm x 12.75 cm]

Available Systems			
Spray Nozzle Kit	Model 455 Spray Valve (0.066" Black PTFE Tubing)	Model 455 Spray Valve (0.095" Black PTFE Tubing)	Model 455 Spray Valve (0.125" Black PE Tubing)
T18001	T18002	T18000	T18004

- Built-in delay system for drip-free operation
- External air-mix design with luer-lock connection
- 100% fully disposable fluid path
- Compatible with low-viscosity (< 5,000 cP), low-pressure (< 30 psi) applications

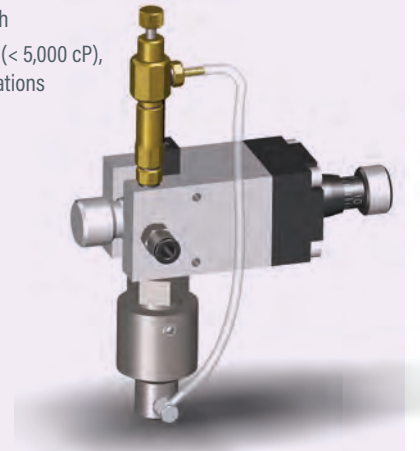

## VISCOTEC ECO-SPRAY MICROSPRAY SYSTEM

The eco-SPRAY by ViscoTec is a precise volume dispenser suitable for various applications in different spraying areas. Its combination of a reliable, endless piston principle and a low-flow spray chamber provides precise spraying of low- to high-viscosity fluids – with high edge definition.

Specifications	
Valve Type	Spray Valve
Activation	eco-SPRAY Controller
Dimensions	Length 228 mm, ø 35 mm
Part Numbers	T18559 ViscoTec eco-SPRAY System (Vale & Controller) T18560 ViscoTec Valve Mounting Fixture T18572 ViscoTec Valve System with 3.8-Liter Mini Ram Pump

- Uniform coating with adjustable spray area
- Compatible with low- to high-viscosity fluids
- Low maintenance and easy to clean





## Accessories

### SYRINGE DISPENSER ACCESSORIES

#### AIR CAPS

All air cap assemblies include an air cap and a tubing assembly. Disposable plastic air cap assemblies are extremely light weight and economical. Reusable aluminum air cap assemblies do not deflect under pressure providing greater air column stability in the syringe barrel. This yields more accurate and consistent volumes.

Part Number	Description
Plastic (for use with the SD-100)	
T17600	Air Cap Adapter, 3 mL
T15479	Air Cap Adapter, 5 mL
T17602	Air Cap Adapter, 10 mL
T17601	Air Cap Adapter, 30 & 55 mL
Aluminum	
T15475	Air Cap Adapter, 5 mL
T15476	Air Cap Adapter, 10 mL
T15477	Air Cap Adapter, 30 & 55 mL



### FLUID & AIR-LINE KITS

#### FLUID LINE KITS

Material lines carry fluid from the reservoir to the dispensing valve.

Part Number	Description
T16787	3/8" OD Polyethylene Fluid-Line Kit, 6' Long
T16793	1/4" OD Polyethylene Fluid-Line Kit, 6' Long

#### AIR LINE KITS

Air line kits contain high-grade tubing and fittings for properly and safely connecting air to the system's reservoir and controller.

Part Number	Description
T16789	Reservoir Air-Line Kit, 11' Long
T16786	Controller Air-Line Kit, 12' Long

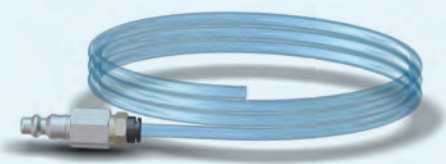

## Accessories

### VALVE CONTROLLERS

#### DVC-345 DIGITAL VALVE CONTROLLER

The DVC-345 digital valve controller provides precise and consistent valve actuation without complex programming. Its internal 4-way solenoid valve operates Dymax or other pneumatic dispense valves. This controller may be operated via foot switch, manual front panel switch, or remote PLC. Cycle time may be set in a range from .001 to 9.999 seconds in .001 second increments.

Specifications	T11146
Power Requirements	120 VAC, 240 VAC, 50/60 Hz, 1/10 Amp
Dimensions	6.25" x 8" x 3.5" [15.9 cm x 20.3 cm x 8.9 cm]
Weight	2.8 lbs [1.27 kg]



### STANDS

#### SYRINGE & SPRAY GUN STANDS

Stands for dispensing syringes and spray guns are ideal for keeping surfaces clean and organized.

Part Number	Description
T15466	Syringe Stand for One Syringe
T15505	Syringe Stand for Three Syringe
T15454	Spray Gun Stand with Drip Cup

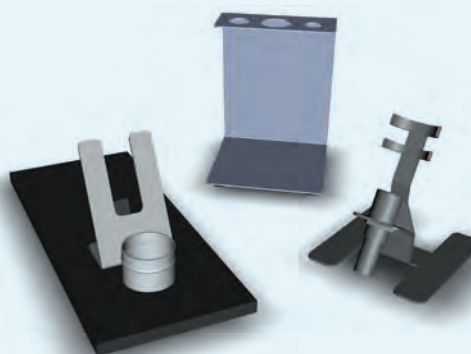

#### LAB STANDS & VALVE MOUNTING ASSEMBLIES

Easily mount a dispensing valve so it can be used in a bench-top system. Lab standards are 24" high and made of aluminum. The mounting hardware is simply screwed into the dispensing valve's mounting holes and then secured onto the lab stand.

Part Number	Description
T15279	24" Lab Stand for Cartridge Reservoir System
T15449	Valve Mounting Assembly, Model 455
T16857	Valve Mounting Assembly, Model 475 & 485
T15450	Valve Mounting Assembly, Model 775
T15451	Valve Mounting Assembly, Model 826



## Accessories

### MATERIAL RESERVOIRS

#### CARTRIDGE RETAINERS

Dymax offers a complete line of cartridge drop-in reservoirs for use with fluid dispensing systems. Five sizes, ranging from 2.5 - 20 oz [74 - 550 mL], are available. The material reservoirs are made of lightweight aluminum and are designed so that they can be securely attached to a Dymax lab stand. Standard cartridge drop-in reservoir packages include a cartridge retainer, retainer cap, adjustment knobs, lab stand, and a quick disconnect. Polyethylene cartridges are sold separate.



#### BOTTLE & PAIL DROP-IN TANKS

For applications where large amounts of material are being dispensed, Dymax offers pressure tanks that can accept bottle and pail size packages. These pressure-tanks have a fully removable lids, allowing for an entire bottle or pail to be placed inside.

Part Number	Description
T17004	1 Gallon Bottle Drop-In Tank
T17859	5 Gallon Bottle Drop-In Tank
T16864	10 Gallon Pail Drop-In Tank



#### MINI RAM PUMP

The Graco® DynaMite™ Mini Ram Pump provides precise and consistent fluid dispensing in a small, compact model. It utilizes an NXT air motor to provide the power necessary to move viscous materials like adhesives, gaskets, maskants, and more from smaller 3.8-liter Dymax pails and other 1-gallon containers. The ram pump excels when used to spray high-viscosity materials and is available as part of the complete Dymax SG-150 high-flow and SG-200 super-flow spray systems. It can also be used in conjunction with any other Dymax dispensing system or valve.

Part Number	Description
T18561	Ram Pump for 3.8 L Pails & Other 1-Gallon Containers



# Accessories

## MATERIAL RESERVOIRS

### RAM PUMP SYSTEMS

The Dymax ram pump system uses a pump to transfer medium to high-viscosity fluids from a pail to the dispensing valve. The ram pump system is designed to dispense from a 5-gallon (20 L) pail and is available in two models to accommodate both straight and tapered pails. The system is designed with a platin that wipes the sides of the pail as the material level lowers. This wiping action minimizes leftover material and reduces waste.

Part Number	Description
T21286-001	5 Gallon, Straight Pail Wiper
T21286-002	5 Gallon, Tapered Pail Wiper



### LEVEL-SENSING RESERVOIRS

Level-sensing reservoirs allow users to accurately monitor material levels during the dispensing process with an adjustable sensor mount. Two sensor system configurations are available allowing integration into cartridge or pressure pot material reservoirs. Both configurations feature an SB-100 controller which activates a warning when the material level in the reservoir reaches a specified low level. Users can adjust the sensor height to their preferred volume. The SB-100 controller also features an external PLC connection that allows for a total line shutdown. Both functions save time and money by stopping the dispense system when material reservoirs are empty.

	Standard	Machine Builder (does not include SB-001 controller)	Upgrade Kit (for existing reservoirs)
12 oz	T17974	T17975	-
20 oz	T17970	T17971	-
32 oz	T17972	T17973	-
1-Gallon	T17985	T18481	T18500

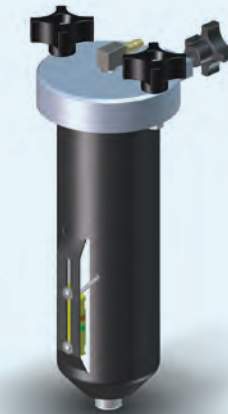

## DISPENSING TIPS & SPRAY CAPS

### VALUE & PREMIUM DISPENSING TIPS

#### Free-Flow Taper Tips (Sold in packages of 50)

Free-flow taper tips are molded from polyethylene with a UV-light block additive, making them compatible with a wide variety of medium-to-high viscosity fluids including UV light-curable materials.



Gauge	Color	Part Number by Length 1.25" [31.75 mm]		ID
		Value	Premium	
14	White	T14-125-TT-50	P3230	0.063" [1.60 mm]
16	Charcoal	T16-125-TT-50	P3231	0.047" [1.19 mm]
18	Green	T18-125-TT-50	P3232	0.033" [0.84 mm]
20	Pink	T20-125-TT-50	P3233	0.023" [0.58 mm]
22	Blue	T22-125-TT-50	-	0.016" [0.41 mm]
25	Red	T25-125-TT-50	P3247	0.010" [0.25 mm]

# Accessories

## DISPENSING TIPS & SPRAY CAPS

### VALUE & PREMIUM DISPENSING TIPS

#### Stainless Steel Dispensing Tips (Sold in packages of 50)

The most versatile of all tips, these dispensing tips are comprised of a polypropylene hub and passivated 304 stainless steel tubing. Stainless steel dispensing tips can be used with a wide variety of low-to-high viscosity fluids including adhesives, epoxies, greases, oils, paints, solder masks, solvents, and more.



Gauge	Color	Part Number by Length				ID
		Value Line		Premium Line		
		0.5" [12.7 mm]	1" [25.4 mm]	0.5" [12.7 mm]	1" [25.4 mm]	
14	White	T14-050-50	T14-100-50	-	-	0.063" [1.60 mm]
15	Amber	T15-050-50	T15-100-50	P3169	P3175	0.052" [1.32 mm]
16	Charcoal	T16-050-50	T16-100-50	-	-	0.047" [1.19 mm]
18	Green	T18-050-50	T18-100-50	P3170	P3176	0.033" [0.84 mm]
20	Pink	T20-050-50	T20-100-50	-	-	0.023" [0.58 mm]
21	Purple	T21-050-50	T21-100-50	P3171	P3178	0.020" [0.51 mm]
23	Orange	T23-050-50	T23-100-50	P3172	P3177	0.016" [0.41 mm]
25	Red	T25-050-50	T25-100-50	-	-	0.010" [0.25 mm]
27	Gray	T27-050-50	T27-100-50	-	-	0.008" [0.20 mm]
30	Lavender	T30-050-50	-	-	-	0.006" [0.15 mm]

#### Polypropylene Flexible Dispensing Tips

(sold in packages of 50)

Polypropylene dispensing tips are ideal for difficult-to-reach applications. These soft, flexible tips prevent scratching of the part when the needle comes in contact with the work surface.

Gauge	Color	Part Number	Length	ID
<b>Value Line</b>				
15	Amber	T15-050-PP-50	0.5" [12.7 mm]	0.052" [1.32 mm]
18	Green	T18-050-PP-50	0.5" [12.7 mm]	0.033" [0.84 mm]
20	Pink	T20-050-PP-50	0.5" [12.7 mm]	0.023" [0.58 mm]
25	Red	T25-050-PP-50	0.5" [12.7 mm]	0.010" [0.25 mm]

#### PTFE-Lined Dispensing Tips (Sold in packages of 50)

PTFE-lined needle tips are ideal for dispensing low-viscosity fluids. They resist clogging, making them great for use with gel cyanoacrylates. PTFE-lined dispensing tips can also be used with anaerobics, solvents, epoxies, grease, oils, pastes, and more.

Gauge	Color	Part Number	Length	ID
<b>Value Line</b>				
21	Gray	T020-050-TL-50	0.5" [12.7 mm]	0.020" [0.51 mm]
30	Pink	T006-050-TL-50	0.5" [12.7 mm]	0.006" [0.15 mm]

## Accessories

### DISPENSING TIPS & SPRAY CAPS

#### VALUE & PREMIUM DISPENSING TIPS

##### Opaque Free-Flow Taper Tips (sold in packages of 10)

Opaque free-flow taper tips are molded from polyethylene.

Gauge	Color	Part Number	Length	ID
Premium Line				
14	White - Opaque	P3431	1.25" [31.75 mm]	0.063" [1.60 mm]
18	Green - Opaque	P3432	1.25" [31.75 mm]	0.033" [0.84 mm]
22	Blue - Opaque	P3433	1.25" [31.75 mm]	0.016" [0.41 mm]
25	Red - Opaque	P3434	1.25" [31.75 mm]	0.010" [0.25 mm]

#### SPRAY GUN CAPS

Dymax offers both flat and round air caps for the SG-100 & SG-200 spray guns. These air caps allow greater spray pattern flexibility.



Part Number	Description
T15697	Flat Spray Air Cap
T15698	Round Spray Air Cap
T18020	Nozzle & Round Cap Kit

### AIR REGULATORS & FILTERS

Accurately monitor and control your dispensing system's air pressure to achieve accurate dispensing.

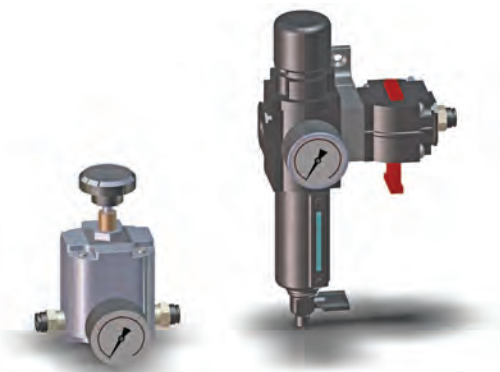

Part Number	Description
T16307	Air Filter Regulator with Air Shut Off
T16629	High-Precision Air Regulator for Fluid Pressure
T17286	Precision Air Regulator, 0-15 PSI (For Use with Spray Guns)
T17289	Precision Air Regulator, 0-30 PSI (For Use with Spray Guns)

# Questionnaire

## DISPENSE PROJECT REQUIREMENTS

### CONTACT INFORMATION .....

Date: \_\_\_\_\_

Name: \_\_\_\_\_ Company: \_\_\_\_\_

Street Address: \_\_\_\_\_

City: \_\_\_\_\_ State: \_\_\_\_\_ Zip Code: \_\_\_\_\_

Phone: \_\_\_\_\_ E-Mail: \_\_\_\_\_

Sales Partner: \_\_\_\_\_

### APPLICATION INFORMATION .....

1	What material are you dispensing? (adhesive, lubricant, cyanoacrylate, urethane, etc.)			
2	Who manufactures this material?	Name: _____ Part #: _____		
3	How many components make up the material?	One	Two	Other (specify): _____
4	What is the package size/style you are working with? (10 mL syr, 1000 mL bottle, 5 gallon pail, etc.)			
5	What is the viscosity of the material?	cP _____		
6	Is the material thixotropic or Newtonian?	Thixotropic	Newtonian	
7	Does the material contain solvents? If yes, which ones?			
8	Does the material contain pigment, fillers, or other suspended solids which might settle out if not agitated in a holding vessel?	If yes, please explain: _____		
9	What is the minimal distance possible from the material supply to the dispense station?			
10	What is the curing mechanism?	<input type="checkbox"/> Light	<input type="checkbox"/> Heat	
		<input type="checkbox"/> Moisture	<input type="checkbox"/> Air	
11	What is the desired shot size?			
12	What shot-to-shot accuracy do you require?	± _____	% of volume dispensed	
13	What is the required valve cycle rate (shots per minute)?			
14	How many dispense stations do you need?			
15	What is the type of dispense needed?	<input type="checkbox"/> Bead	<input type="checkbox"/> Potting	<input type="checkbox"/> Shot
		<input type="checkbox"/> Spray	<input type="checkbox"/> Encapsulation	<input type="checkbox"/> Other, specify _____

# Questionnaire

## DISPENSE PROJECT REQUIREMENTS

### APPLICATION INFORMATION .....

16	How will the dispensing be done?	<input type="checkbox"/> Operator Applied <input type="checkbox"/> Semi-Automated <input type="checkbox"/> Fully Automated Specify:
17	Are you currently using a dispense system? If yes, what would you like to improve?	
18	Please list any special requirements of your application:	
19	Describe your part geometry:	Gap sizes:  Channel to hold adhesives or flat surface?  Size of parts and area to be coated or dispensed onto:

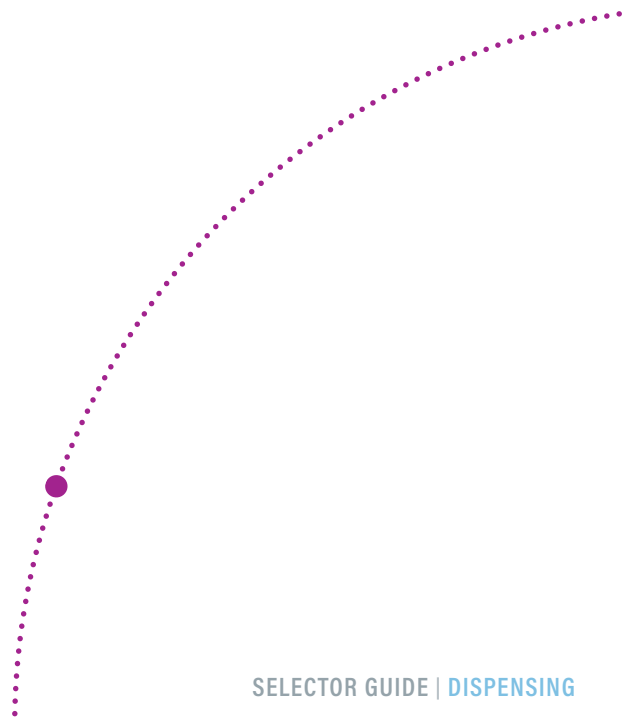



## Equipment Programs

Take advantage of the opportunity to evaluate Dymax equipment with our Try & Buy Program or upgrade your existing light-curing equipment using our new Trade-In Program.

**Try & Buy:** Dymax Try & Buy is a low-risk way to evaluate Dymax equipment in your application before purchasing it. After the two-week trial period, rental of the unit will be billed monthly. Typically, after six payments, the system is yours to keep. This program applies to curing and dispense equipment systems only, and excludes all consumable parts and accessories.

**Trade-In:** Upgrade your existing light-curing equipment to the latest Dymax model regardless of what brand you're using today. The program allows one trade-in per purchase of a new, full price piece of Dymax equipment. Conditions and exclusions apply.

For more information, reach out to Dymax Customer Support or submit an application online at [dymax.com/sales-support/contact-us](https://dymax.com/sales-support/contact-us).



[www.dymax.com](https://www.dymax.com)

### Americas

USA | +1.860.482.1010 | [info@dymax.com](mailto:info@dymax.com)

### Europe

Germany | +49 611.962.7900 | [info\\_de@dymax.com](mailto:info_de@dymax.com)  
Ireland | +353 21.237.3016 | [info\\_ie@dymax.com](mailto:info_ie@dymax.com)

### Asia

Singapore | +65.67522887 | [info\\_ap@dymax.com](mailto:info_ap@dymax.com)  
Shenzhen | +86.755.83485759 | [info@hanarey.com](mailto:info@hanarey.com)  
Hong Kong | +852.2460.7038 | [dymaxasia@dymax.com](mailto:dymaxasia@dymax.com)  
Korea | +82.31.608.3434 | [info\\_kr@dymax.com](mailto:info_kr@dymax.com)

©2021-2023 Dymax Corporation. All rights reserved. All trademarks in this guide, except where noted, are the property of, or used under license by, Dymax Corporation, U.S.A.

Technical data provided is of a general nature and is based on laboratory test conditions. Dymax does not warrant the data contained in this bulletin. Any warranty applicable to the product, its application and use, is strictly limited to that contained in Dymax's standard Conditions of Sale. Dymax does not assume responsibility for test or performance results obtained by users. It is the user's responsibility to determine the suitability for the product application and purposes and the suitability for use in the user's intended manufacturing apparatus and methods. The user should adopt such precautions and use guidelines as may be reasonably advisable or necessary for the protection of property and persons. Nothing in this bulletin shall act as a representation that the product use or application will not infringe a patent owned by someone other than Dymax or act as a grant of license under any Dymax Corporation Patent. Dymax recommends that each user adequately test its proposed use and application before actual repetitive use, using the data contained in this bulletin as a general guide.

SG012DA 06/05/2023