

Model 775 Dispensing Systems

User Guide

Contents

Safety	2
Using Safe Operating Pressures	3
Configuration Overview	4
Key System Connections	5
Dispensing Tips	6
System Configurations	7
A - Systems Using a Cartridge Retainer.....	8
B - Systems Using a Bottle Drop-In Tank.....	9
C - Systems Using a 10-Gallon Pressure Tank	13

Safety

Using Safe Operating Pressures

Pressurizing the components in the dispensing system beyond the maximum recommended pressure can result in the rupturing of components and serious personal injury. To minimize the risk of rupturing components and injury, do not exceed the maximum operating pressure of the components in your fluid dispensing system.

Operating Specifications

- Recommended compressed air supply pressure to air filter/regulator = 60 to 80 psi (4.1 to 5.5 bar)
- Recommended pressure setting at air filter/regulator = 75 psi (5.2 bar)
- Maximum pressure setting at air filter/regulator = 100 psi (6.9 bar)
- Power required = 110V power receptacle (customer supplied)

Configuration Overview

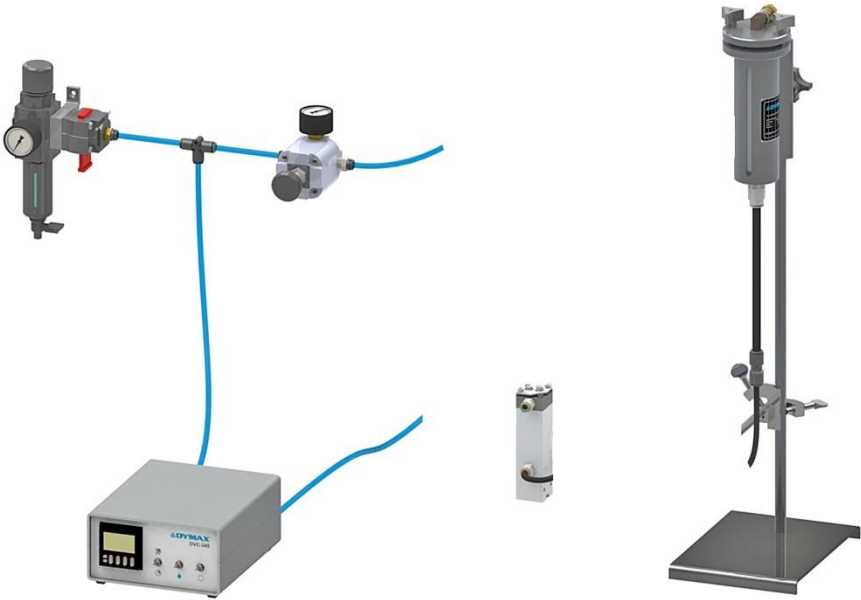

1

Controls

Dymax valves and digital controller provide precise and consistent actuation.

- Pneumatic function
- Footswitch, manual, or PLC controlled
- Easy to operate
- Manual or timed dispense mode

2

Dispensing Valve & Accessories

Dymax dispensing valves for handheld and bench-top applications deliver precision solutions for low- to high-viscosity materials. Various style tips and accessories are also available.

3

Reservoirs

Dymax carries a variety of material reservoirs to accommodate most dispensing applications.

- Range of volumes from 6 oz. cartridges to 10-gallon pressure tanks
- Easy change-over and control

Key System Connections

NOTE: Figures 1-4 apply to all systems.

Figure 1.
Valve Air & Material Connections

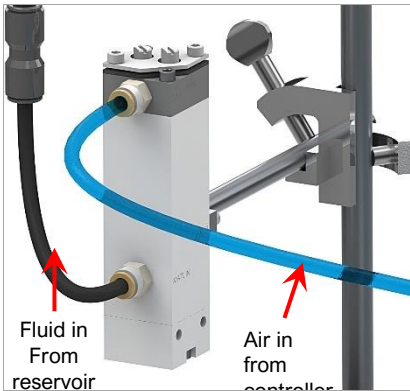

Figure 2.
Controller Connections, Rear Panel

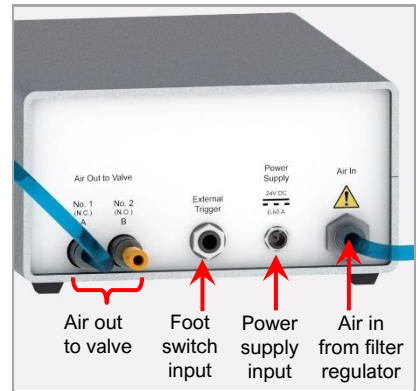

Figure 3.
High-Precision Regulator Connections

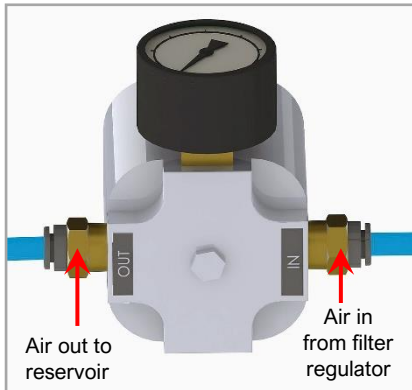
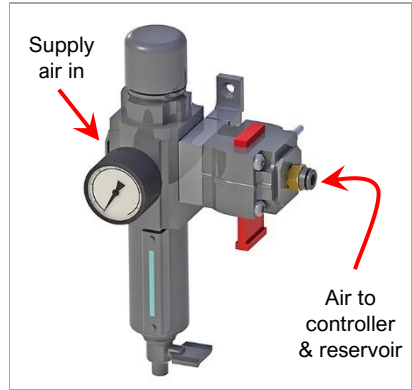

Figure 4.
Filter Regulator







Dispensing Tips

A variety of both needle and taper dispense tips in various lengths, gauges, and shapes are available from Dymax. Tip selection is critical when precision is required and the length, shape, and size of the tip used will define the shape of the fluid deposit and the performance of your dispense system.

The following tips are included with this system, and are recommended for use with the Model 485 dispensing valve. Either tip kit can be used depending on the exact viscosity and application.

P3423 Dispensing Tip Kit for Medium- to High-Viscosity Materials (>500 cP)

Part #	Color	Description	
P3169	Amber	15 GA Needle Tip	
P3170	Green	18 GA Needle Tip	
P3232	Green	18 GA Tapered Tip	
P3247	Red	25 GA Tapered Tip	

Additional kits are available (sold separately) for a range of applications using lower viscosity materials.



For assistance in optimal tip selection, contact Dymax Application Engineering. Visit www.dymax.com to see Dymax's dispensing tip selection.

System Configurations



A Systems Using a Cartridge Retainer (p. 8-9)



B Systems Using a Bottle Drop-In Tank (p. 10-12)

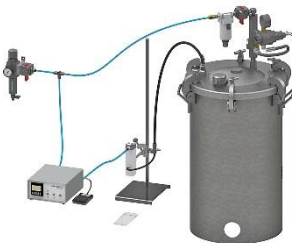

C Systems Using a 10-Gallon Pressure Tank (p. 13-15)

A - Systems Using a Cartridge Retainer

Packaged Components

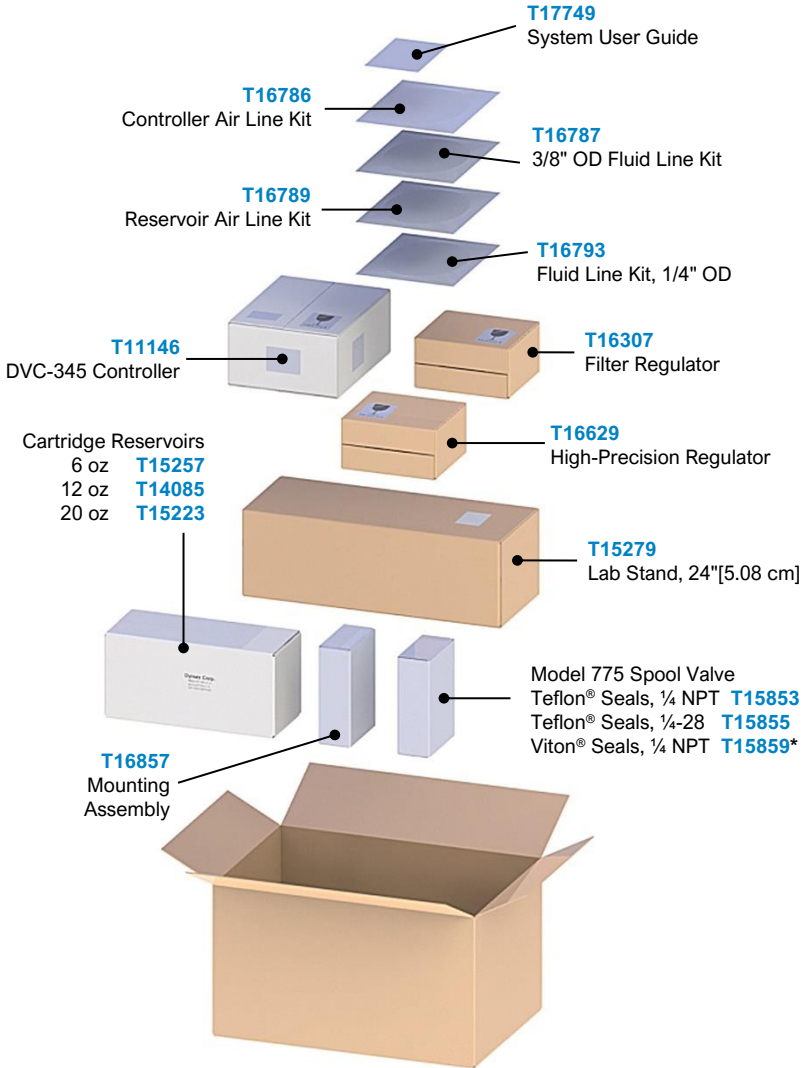

*Viton® seals are not compatible with UV-curable adhesives

Assembled System

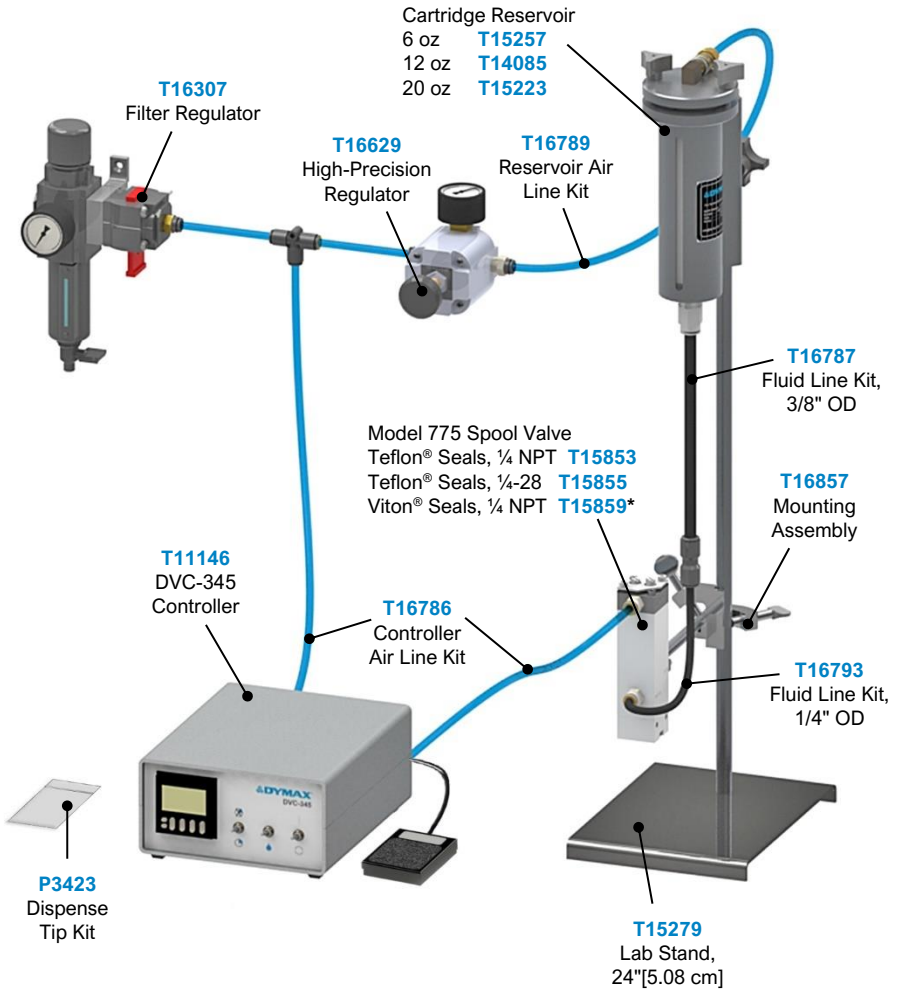

User Supplied Items	Spare Parts
60-80 psi air supply, 1/4 NPT male fitting 110V power receptacle	1/4" male to 1/4" quick-disconnect fitting

*Viton® seals are not compatible with UV-curable adhesives

B - Systems Using a Bottle Drop-In Tank

Packaged Components

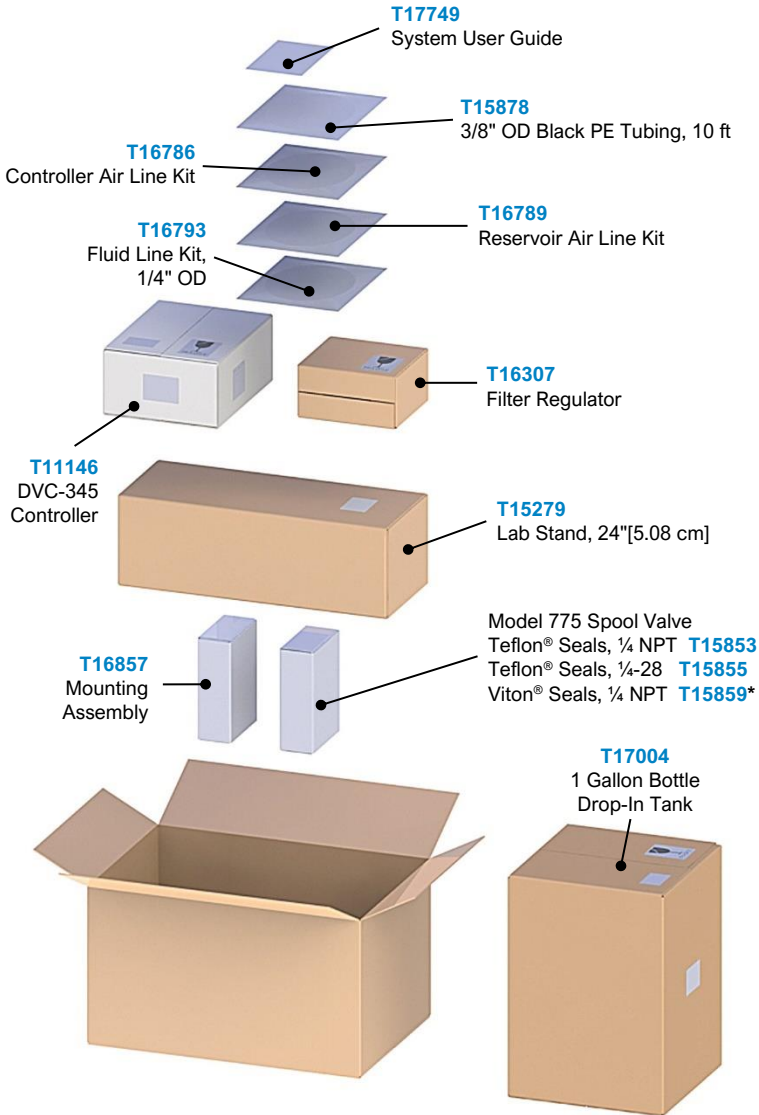

*Viton® seals are not compatible with UV-curable adhesives

Assembled System

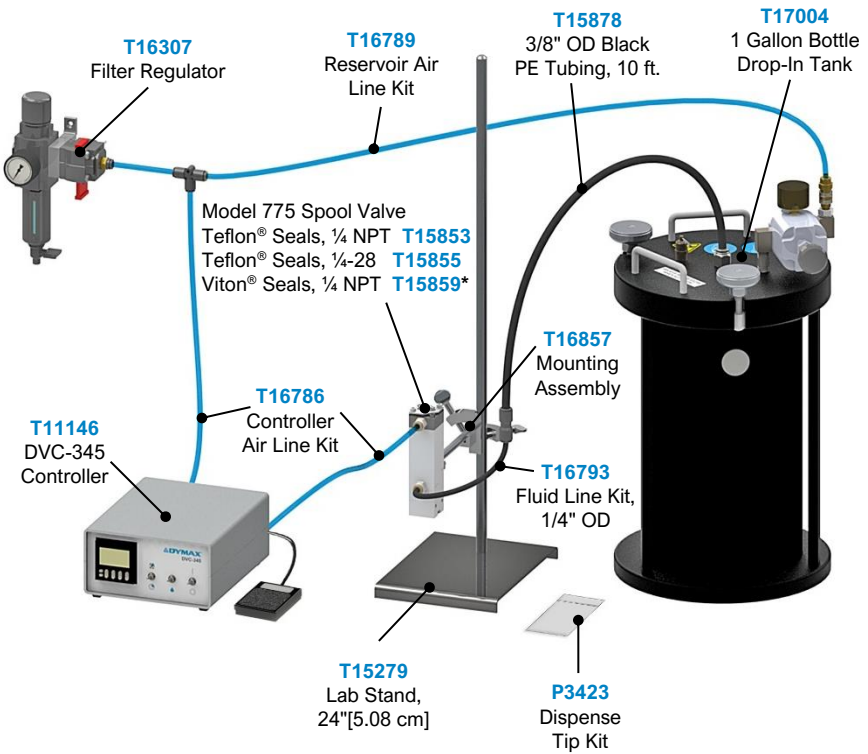

User Supplied Items	Spare Parts
60-80 psi air supply, 1/4 NPT male fitting 110V power receptacle	1/4" male to 1/4" quick-disconnect fitting

*Viton® seals are not compatible with UV-curable adhesives

Installing the Fluid Line to the Reservoir

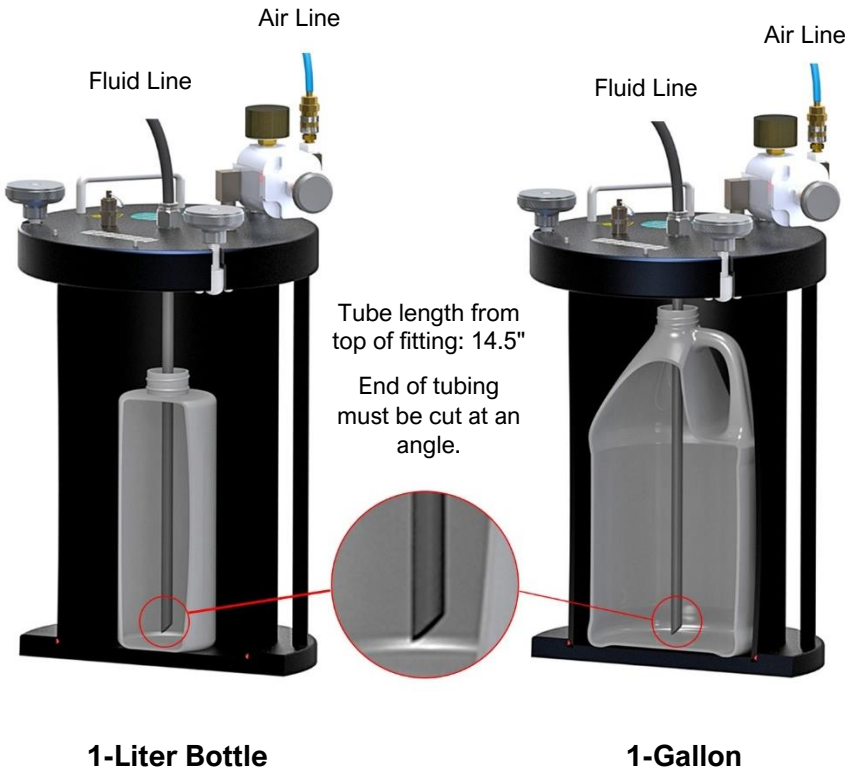

C - Systems Using a 10-Gallon Pressure Tank

Packaged Components

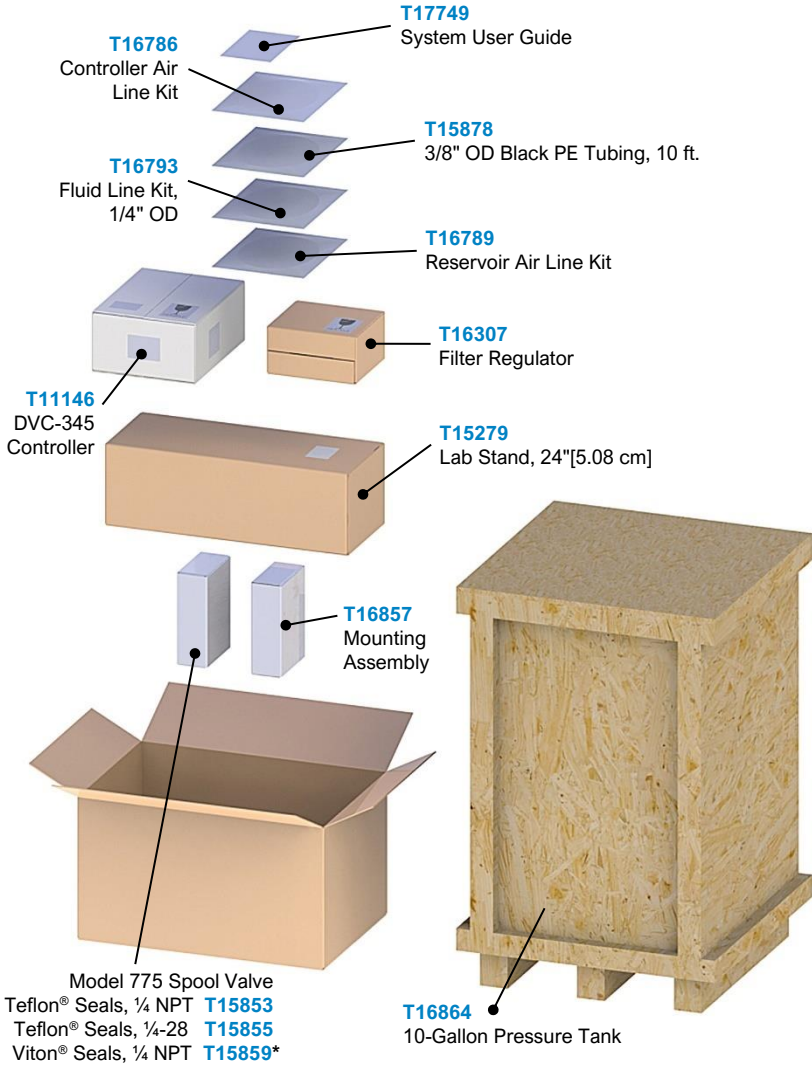

*Viton® seals are not compatible with UV-curable adhesives

Assembled System

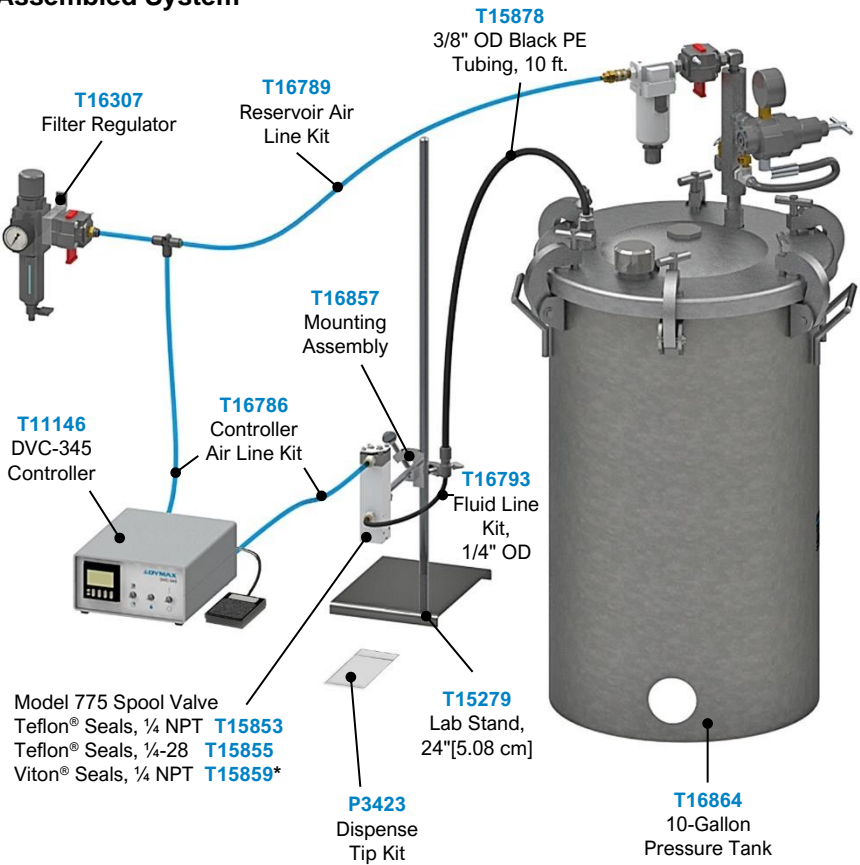

User Supplied Items	Spare Parts
60-80 psi air supply, 1/4 NPT male fitting 110V power receptacle	1/4" male to 1/4" quick-disconnect fitting

*Viton® seals are not compatible with UV-curable adhesives

Installing the Fluid Line to the Reservoir

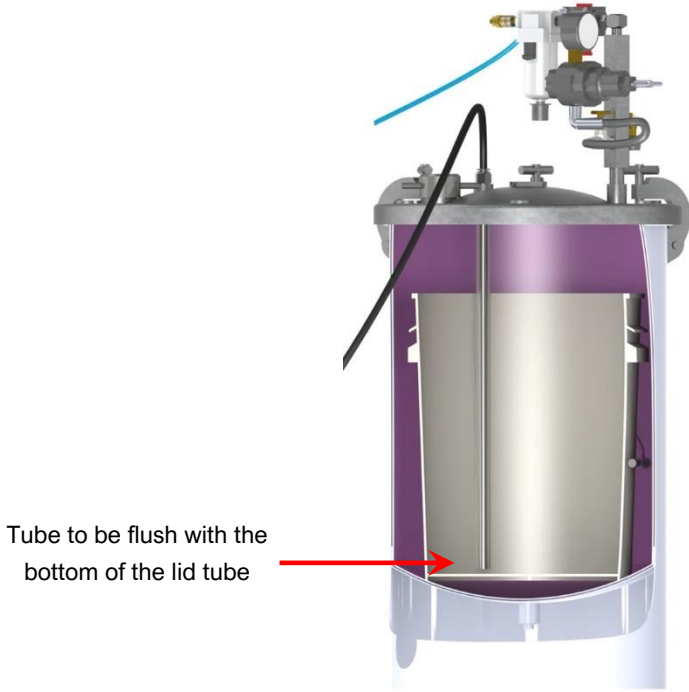

15-Liter Pail



Americas

USA | +1.860.482.1010 | info@dymax.com

Europe

Germany | +49 611.962.7900 | info_de@dymax.com

Ireland | +353 21.237.3016 | info_ie@dymax.com

Asia

Singapore | +65.67522887 | info_ap@dymax.com

Shanghai | +86.21.37285759 | dymaxasia@dymax.com

Shenzhen | +86.755.83485759 | dymaxasia@dymax.com

Hong Kong | +852.2460.7038 | dymaxasia@dymax.com

Korea | +82.31.608.3434 | info_kr@dymax.com

© 2013-2014 Dymax Corporation. All rights reserved. All trademarks in this guide, except where noted, are the property of, or used under license by Dymax Corporation, U.S.A. Viton and Teflon are registered trademarks of DuPont.

Please note that most dispensing system applications are unique. Dymax does not warrant the fitness of the product for the intended application. Any warranty applicable to the product, its application and use is strictly limited to that contained in Dymax standard Conditions of Sale published on our website. Dymax recommends that any intended application be evaluated and tested by the user to ensure that desired performance criteria are satisfied. Dymax is willing to assist users in their performance testing and evaluation. Data sheets are available for valve controllers or pressure pots upon request. MAN062 T17749 1/7/2014